

# Firebird OLTP Test

Pavel Zotov, Firebird QA



MOSCOW  
EXCHANGE

*Platinum*



*Platinum*



*Platinum*

*Platinum*



THANK YOU!

# ABOUT THIS TEST

- Emulates work of real-life app (car service)
  - Settings for init pop., warm-up & measure.
- Does not require 3rd party utilities.
- Workload modes: small, medium, heavy.
- Main purpose: get maximal performance.
- Performance report auto creating.
  - Log every unit run and its result.
- Test home: [www.firebirdtest.com](http://www.firebirdtest.com) (to be published)
- Author: Pavel Zotov, [p519446@yandex.ru](mailto:p519446@yandex.ru)

# WHY THIS TEST

- Stress-test of Firebird stability
- Logic as in real-life, workload much harder
- Compare performance:
  - \* “hardware-1” vs “hardware-2”
  - \* Firebird 3.0 vs 2.5
  - \* SS vs SC vs CS
  - \* database settings: page\_size, FW, etc
- Create client-side app for distribution as example (planning).

# MODEL: INTRO

## Main entities:

- Catalogue of products & shopping cart
- Contractor
- Document header
- Document line
- Turnover log
- Aggregated remainder
- FIFO distribution: source & target

# MODEL: STOCK ENTITIES

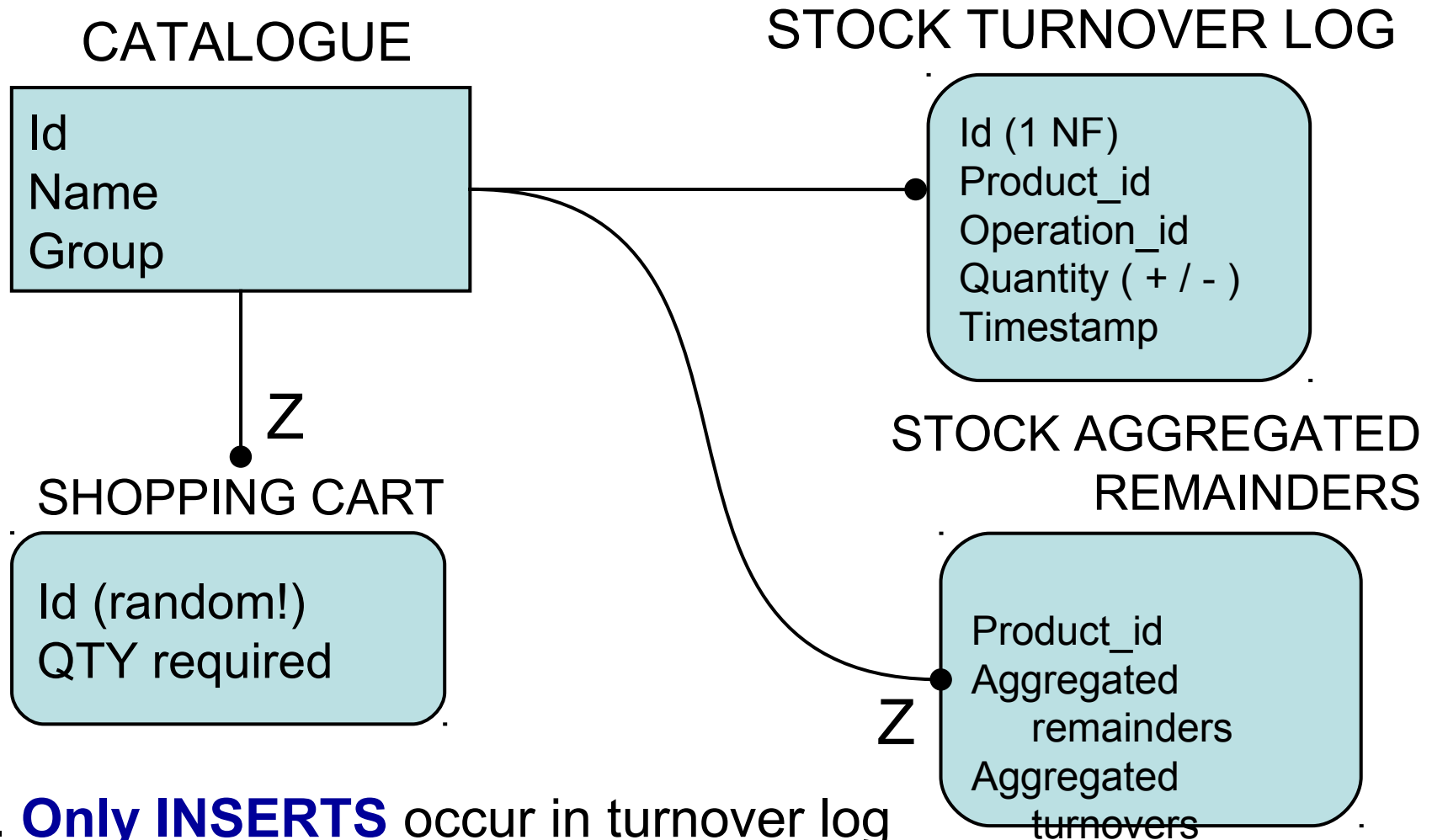

- 1. **Only INSERTS** occur in turnover log
- 2. Aggregating is “serialized” with high frequency

# MODEL: CONTRACTORS

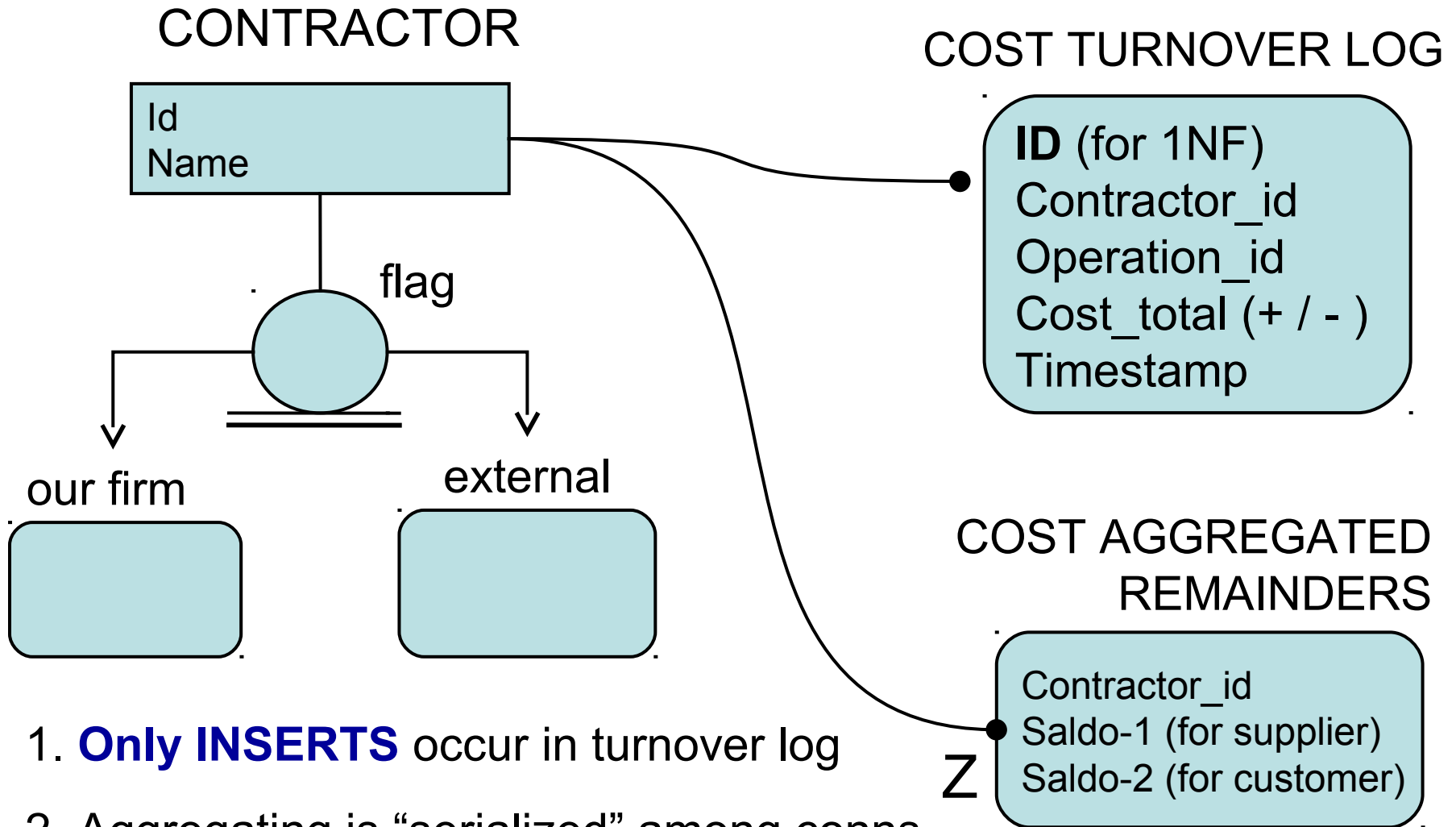

1. **Only INSERTS** occur in turnover log
2. Aggregating is “serialized” among conns.
3. “Our firm” => NO reserve after shipping

# MODEL: DOCS & TURNOVERS

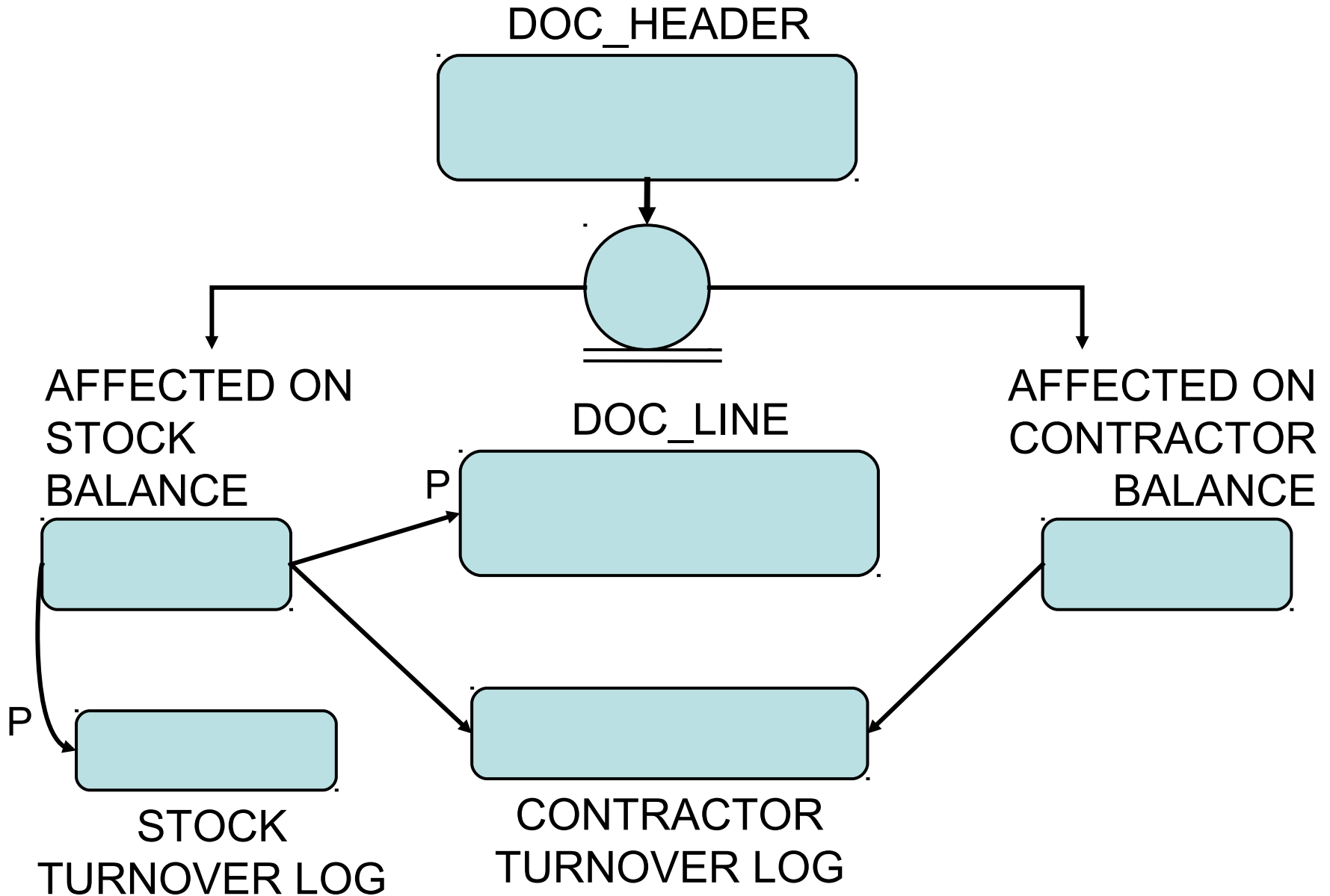



# DATABASE SCHEMA

- Documents flow (operations)
- Turnovers and balances
- Effect from operations
- Producer - consumer logic

# DOCUMENTS FLOW

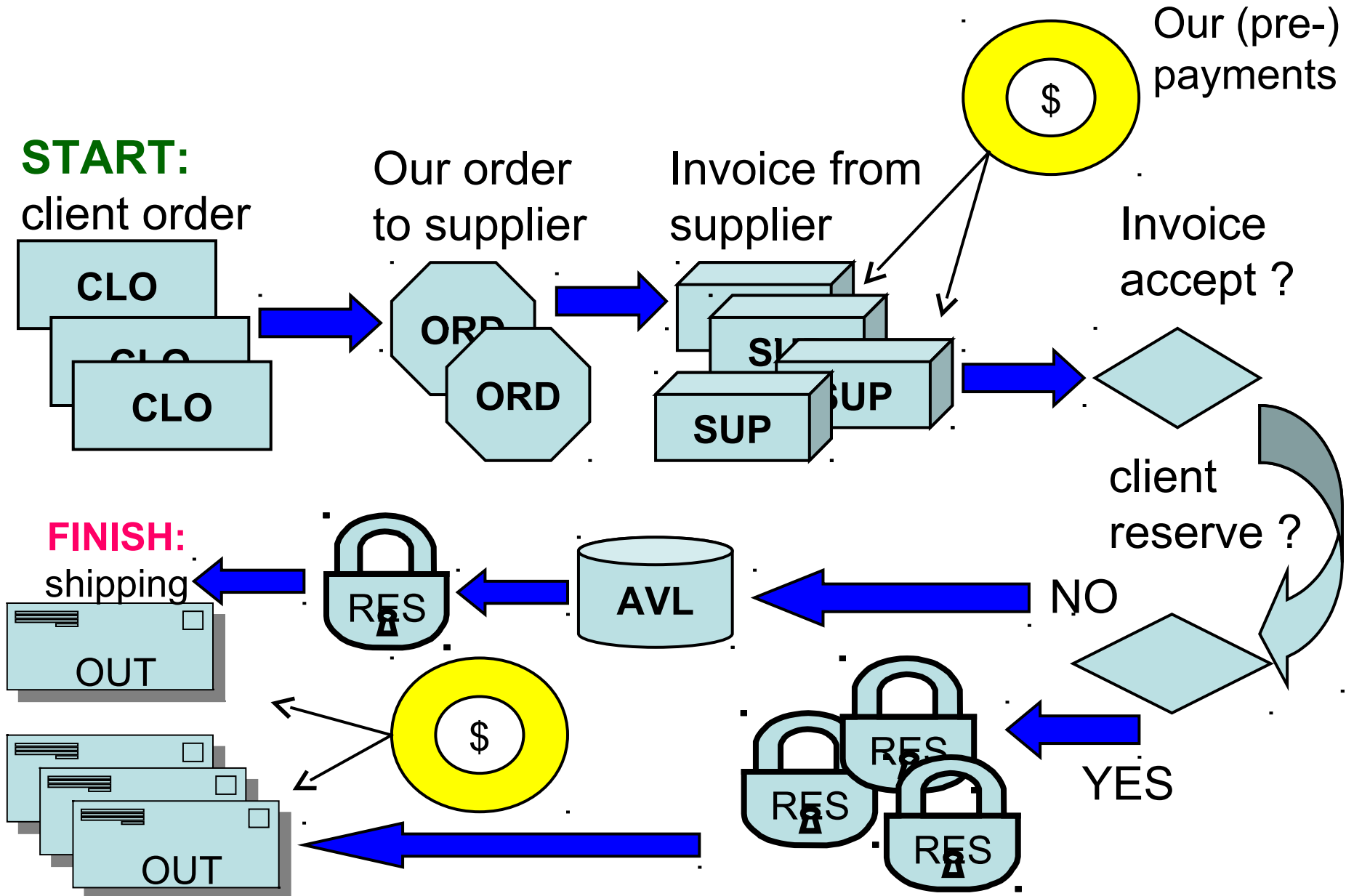

# TURNOVERS AND BALANCES

## STOCK BALANCES:

- **CLO**: client order
- **ORD**: order to supplier
- **SUP**: invoice from suppl.
- **AVL**: available
- **RES**: reserve for client

## STOCK TURNOVERS:

- **INC**: total incomings
- **OUT**: total outgoings

## ACCOUNTANT BALANCE:

$$= \text{INC} - \text{OUT}$$

## MONETARY BALANCE & TURNOVER:

- balance of contractor as supplier or as customer:  
is calculated in purchasing or retailing prices
- (pre-) payment to supplier / (pre-)payment from client

# CHANGES OF REMAINDERS

- Catalogue -> **Client** order
- Supplier **order**: gather rows from client orders
- Supplier invoice: gather rows from **supplier** orders
- Check and accepting invoice: add its content to **available** remainders
- Search for client orders that still need some goods to be **reserved**
- Create **reserve**
- Products shipping to customers

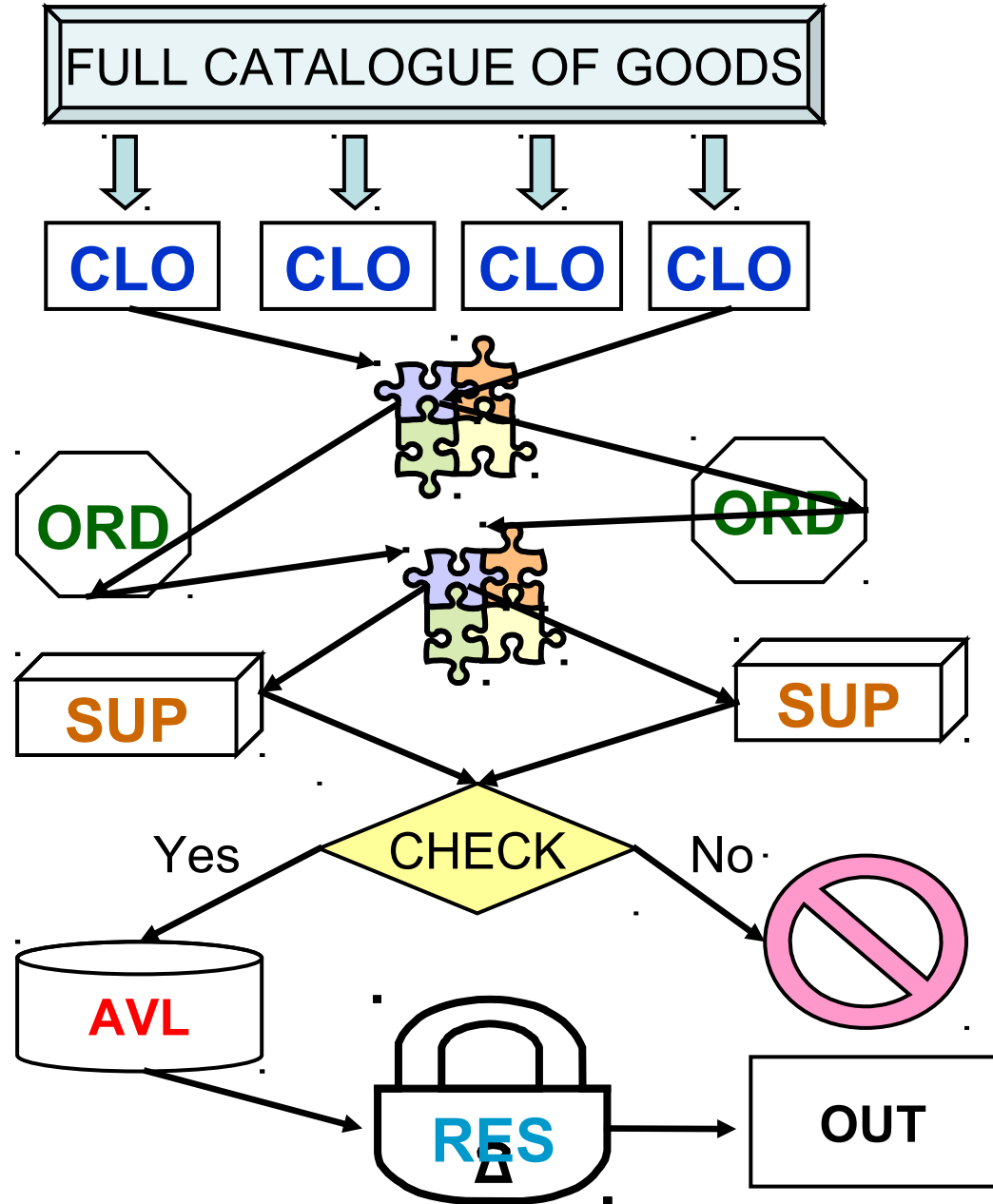

# EFFECT FROM OPERATIONS

BUSINESS OPERATION	CLO	ORD	SUP	AVL	RES	INC	OUT
CUSTOMER ORDER	1						
OUR ORDER TO SUPPLIER	-1	1					
WE GET INVOICE FROM SUPPLIER		-1	1				
WE VERIFIED & ACCEPT INVOICE			-1	1		1	
RESERVE FOR CLIENT				-1	1		
SALE OF PRODUCTS					-1		1

## Legend:

**CLO** = remainder in customer orders

**ORD** = remainder in orders to supplier

**SUP** = not-delivered invoices

**AVL** = 'on-hand' remainder

**RES** = remainder of reserved goods

**INC** = total incomings

**OUT** = total outgoing

# Producer-Consumer: **why?**

## **Too many row-level lock conflicts:**

- When need to update **remainder**
- When need to change amount in document **line**
- When need to change total cost in document **header**

## **Performance impact:**

Earlier test versions: approx. 80% of application unit calls failed with lock conflict.

No sense to measure performance in this case.

# Producer-Consumer: **BALANCES**

Attempt to apply same schema as for contractor balances:

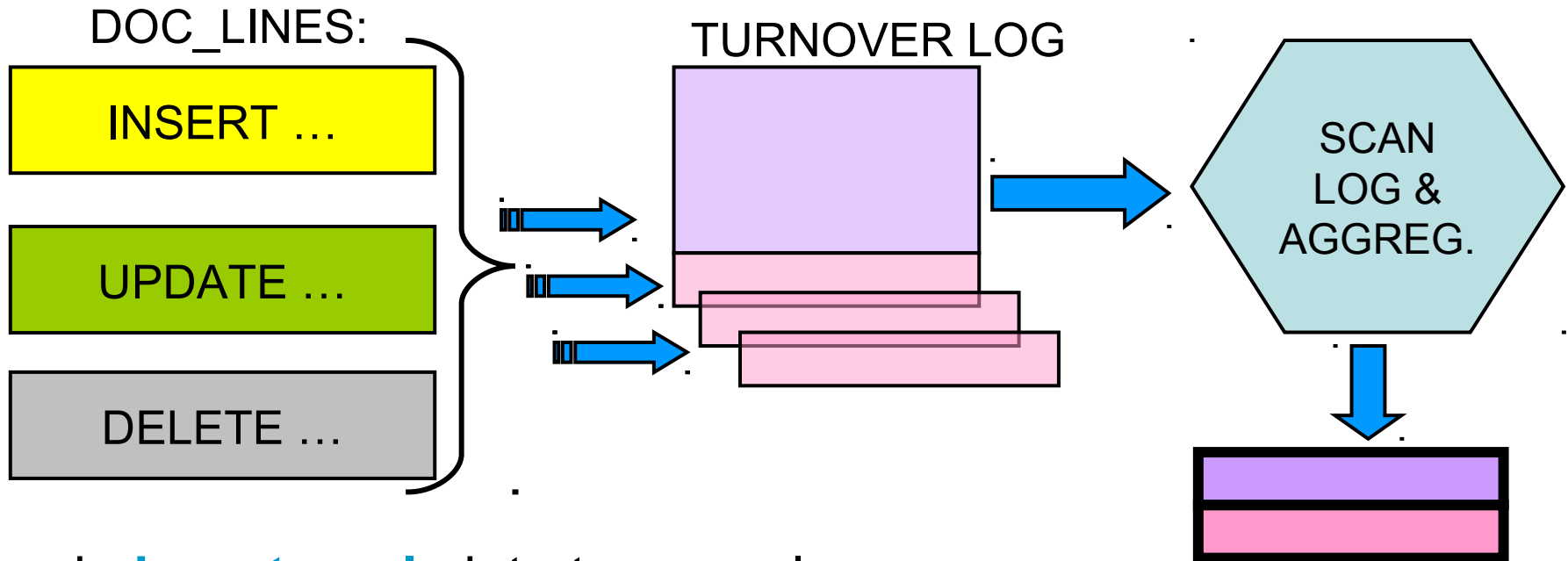

- do **inserts only** into turnover log
- only **one attach** runs aggregation
- **clear** turnover log after aggregation finishes

**Q: how to provide constraint "REMAINDER >= 0" ?**

# Producer-Consumer: QUANTITIES

## Producer:

```
INSERT INTO  
DOC_LINES(..., QTY)  
VALUES( ..., 5 );
```

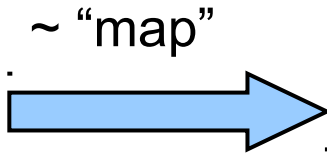

Source for future qty spreading:

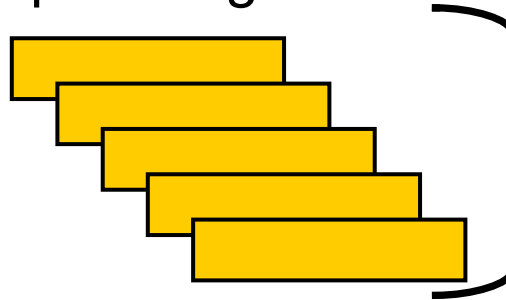

ADD 5 ROWS  
FOR QTY = 5

## Consumers:

Tx1: wants Q=3

Tx2: wants Q=2

Tx3: wants Q=4

id = 125

id = 126

id = 127

id = 128

id = 129

↑  
FREE

id = 125

id = 126

id = 127

id = 128

id = 129

↑  
LOCKED

Tx1: gets Q=3

Tx2: gets Q=2

Tx3: gets NONE

Don't allow to take more than **source** can give!



# Producer-Consumer: DOC TOTALS

**Producer:**

DOC\_HEADER

```
INSERT(..., COST)
VALUES(..., 5400)
```

~ "map"



**Source** for future cost spreading:

id=1 \$1000	id=4 \$1000
id=2 \$1000	id=5 \$1000
id=3 \$1000	id=6 \$400

**Consumers:**

Tx1: wants \$2100

Tx2: wants \$1700

Tx3: wants \$800

id=1 \$1000	id=1 \$1000	→	id=1 \$1000
id=2 \$1000	id=2 \$1000	→	id=2 \$1000
id=3 \$1000	id=3 \$1000	→	\$900   \$100
id=4 \$1000	id=4 \$1000	→	id=4 \$1000
id=5 \$1000	id=5 \$1000	→	\$300   \$700
id=6 \$400	id=6 \$1000	→	\$200   \$800

↑  
FREE

↑  
LOCKED

# PRODUCER-CONSUMER: OVERALL

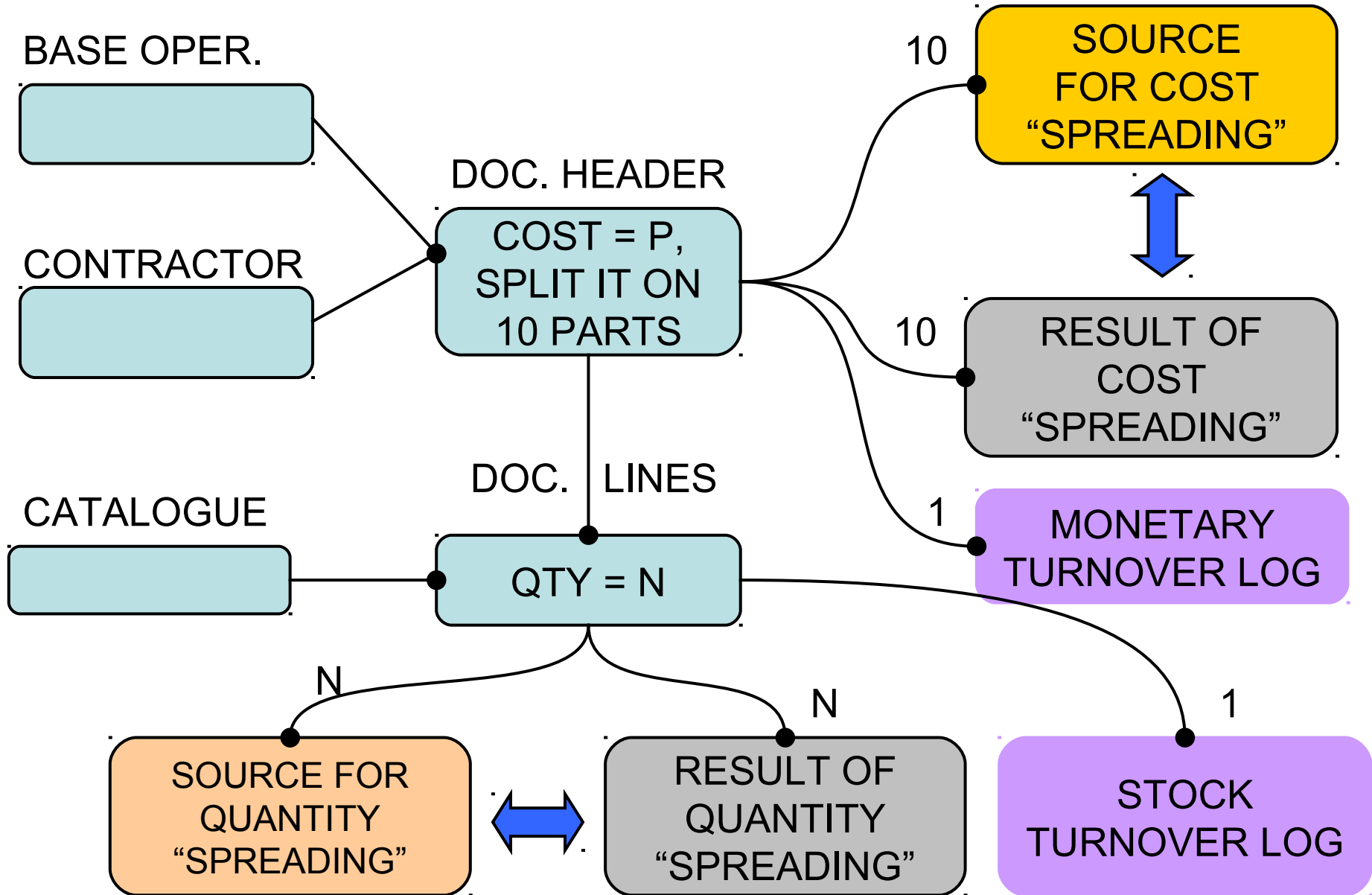

# HOW TEST WORKS

- Phases of test run
- Sketch of measurement
- Auto make performance report

# PHASES OF TEST RUN

Read config:  
get "init\_docs"  
=> save to "A"

How many docs  
now we have ?  
=> save to "B"

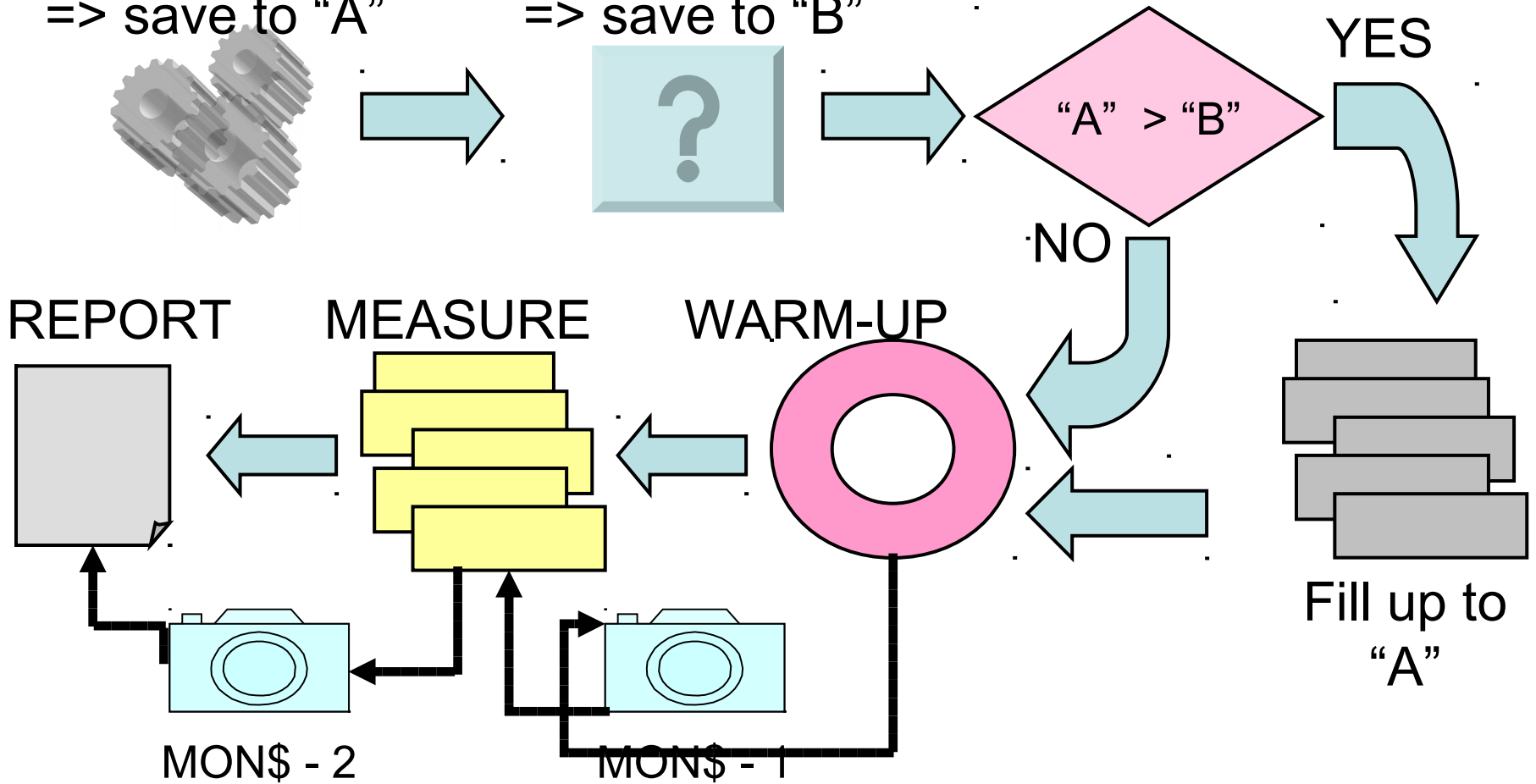

# SKETCH OF MEASUREMENT

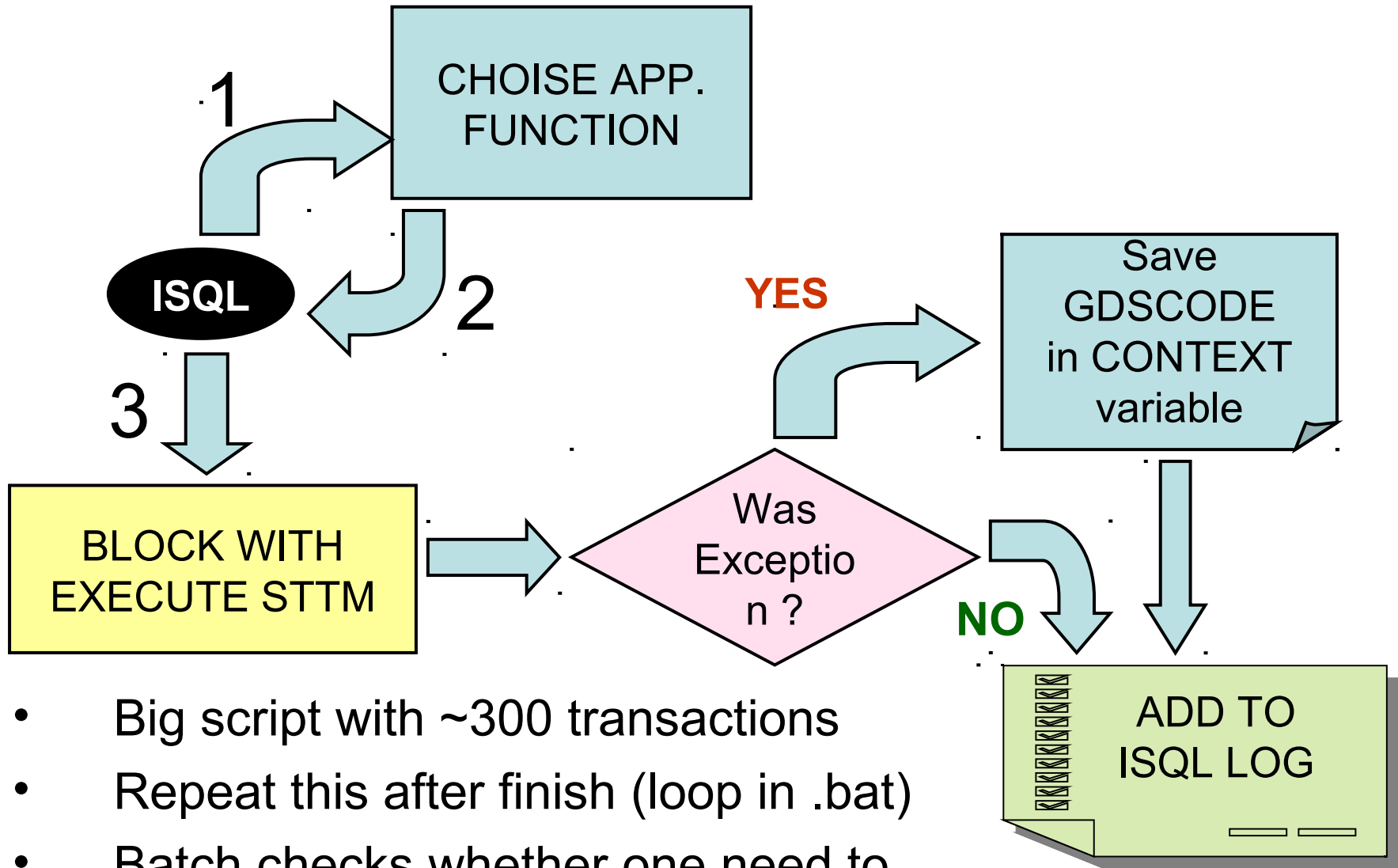

- Big script with ~300 transactions
- Repeat this after finish (loop in .bat)
- Batch checks whether one need to exit from loop and terminate itself

# AUTO PERFORMANCE REPORT

Read config:  
get %tmpdir%  
setting (path)

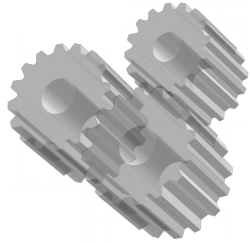

1run\_oltp\_emul.bat

start

worker

worker

worker

worker

1  
ISQL

2  
ISQL

3  
ISQL

4  
ISQL

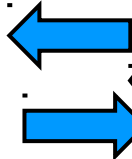
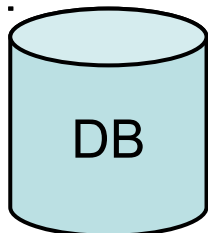

Report SP

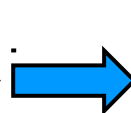

Report



File: %**TMPDIR**% \  
oltp\_NN\_performance

# PERFORMANCE: RESULTS

- Performance: how to measure ?
- Results:
  - performance overall
  - dynamic change of performance
  - explanation
- What it was tested ?
  - Hardware, Firebird & database settings
- Graphics

# PERFORMANCE: IN WHAT “UNITS” ?

Performance rating:  $P = S / M$ ,

where:

S = number of *successfully* completed actions, when gdscode is NULL

M = durability of workload period, in minutes



# PERFORMANCE: REPORTS

Following reports can be created:

- 1) overall;
- 2) dynamic (“how Firebird gets tired”);
- 3) detailed;
- 4) exceptions occurred

# WHAT IS WAS TESTED ?

- Server:
  - 12 core CPU, 2GHz, RAM 32 Gb HDD IBM SCSI
  - OS: Linux RHEL, kernel 2.6.39
- Firebird versions: 2.5 SS, 2.5 SC, 3.0 SS, 3.0 SC
- Database settings:
  - FW = ON and OFF
  - page\_size = 8192

Number of attaches: 25, 50, 100, 150

- Initial number of documents: 30000. Database size: ~410 Mb
- Database warm-up time: 10 minutes (3.0), 15 minutes (2.5)
- Measured time: mostly 180 minutes, several times 12 hours

# Changes in firebird.conf

**Following parameters need to be changed:**

- **ExternalFileAccess = Restrict <path>**  
(place when 'STOPTEST.TXT' will live)
- **DefaultDBCACHEPages**  
increase at least to 512 for SC or CS  
increase at least to 65535 for SS
- **LockHashSlots**  
increase to 22111
- **TempCacheLimit**  
increase at least to 256M

# RESULTS - PERFORMANCE OVERALL

Successful business actions per minute, in average:

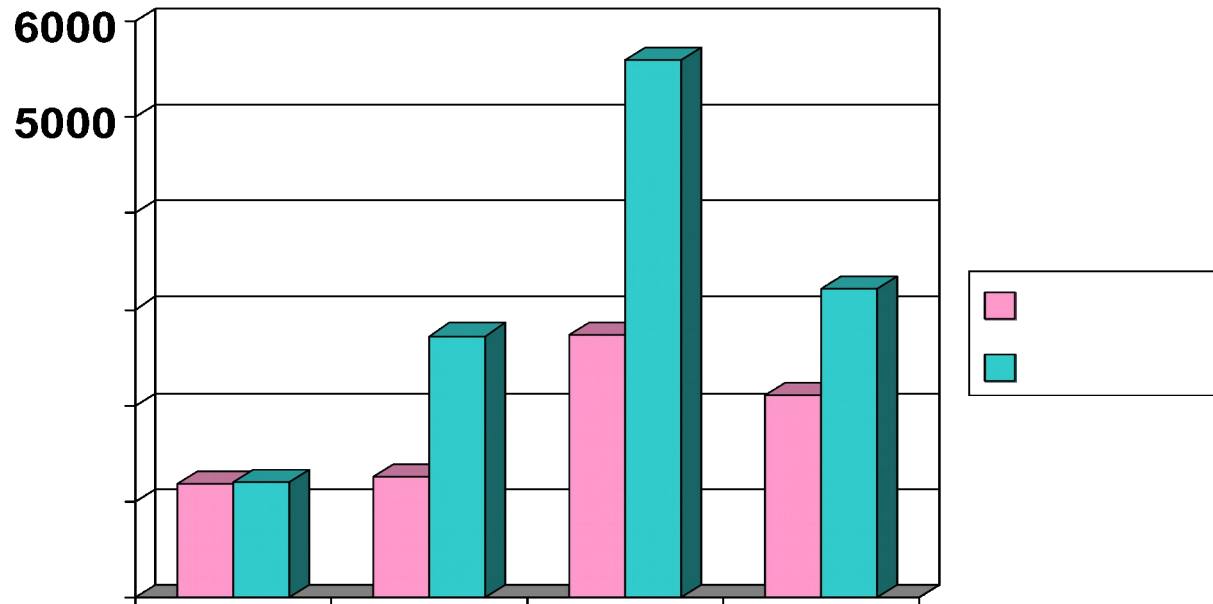

Number of attaches: 100

Warm-up time: 10 minutes

Measurement time: 180 minutes

DefaultDbCachePages = 512K

LockHashSlots = 22111

TempCacheLimit = 2 Gb

# PERFORMANCE IN TIME, FW = ON

Ho

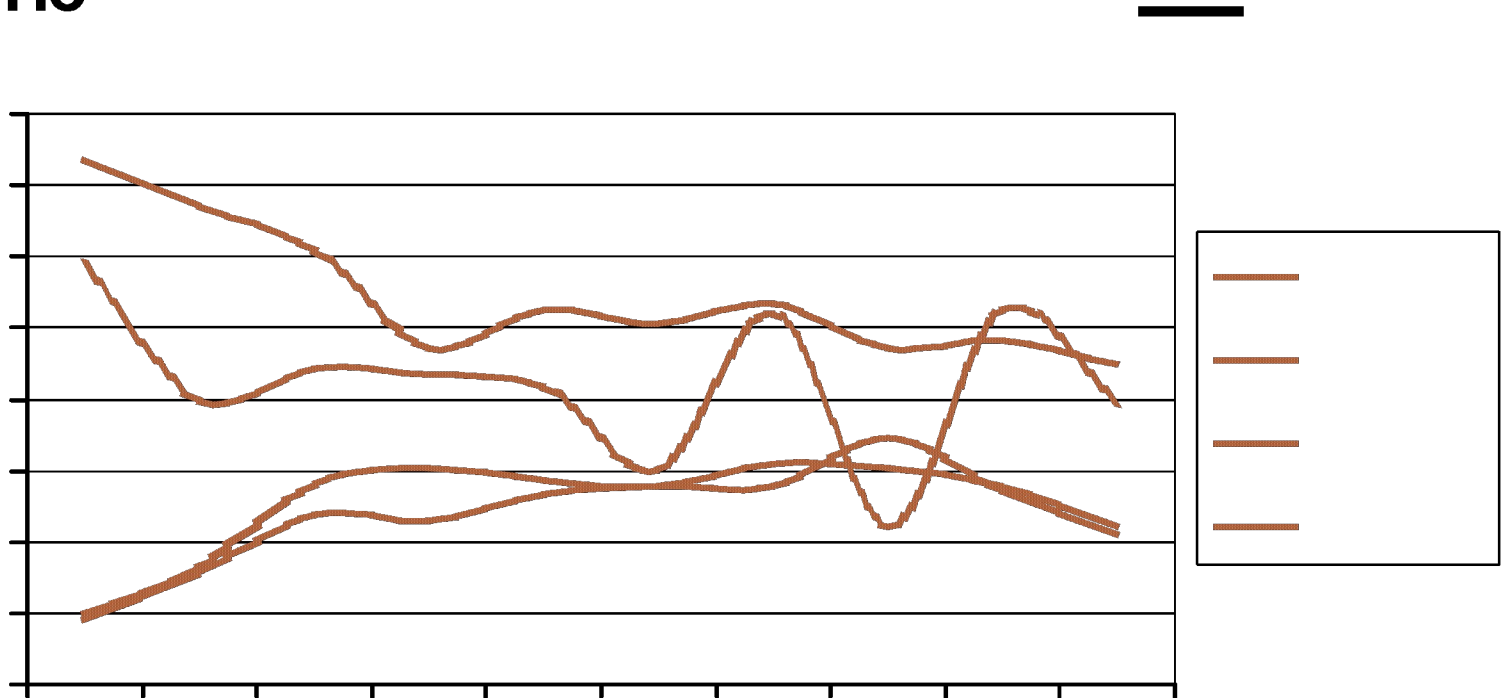

(successful business actions per minute, in average)

# PERFORMANCE IN TIME, FW = OFF

Hov

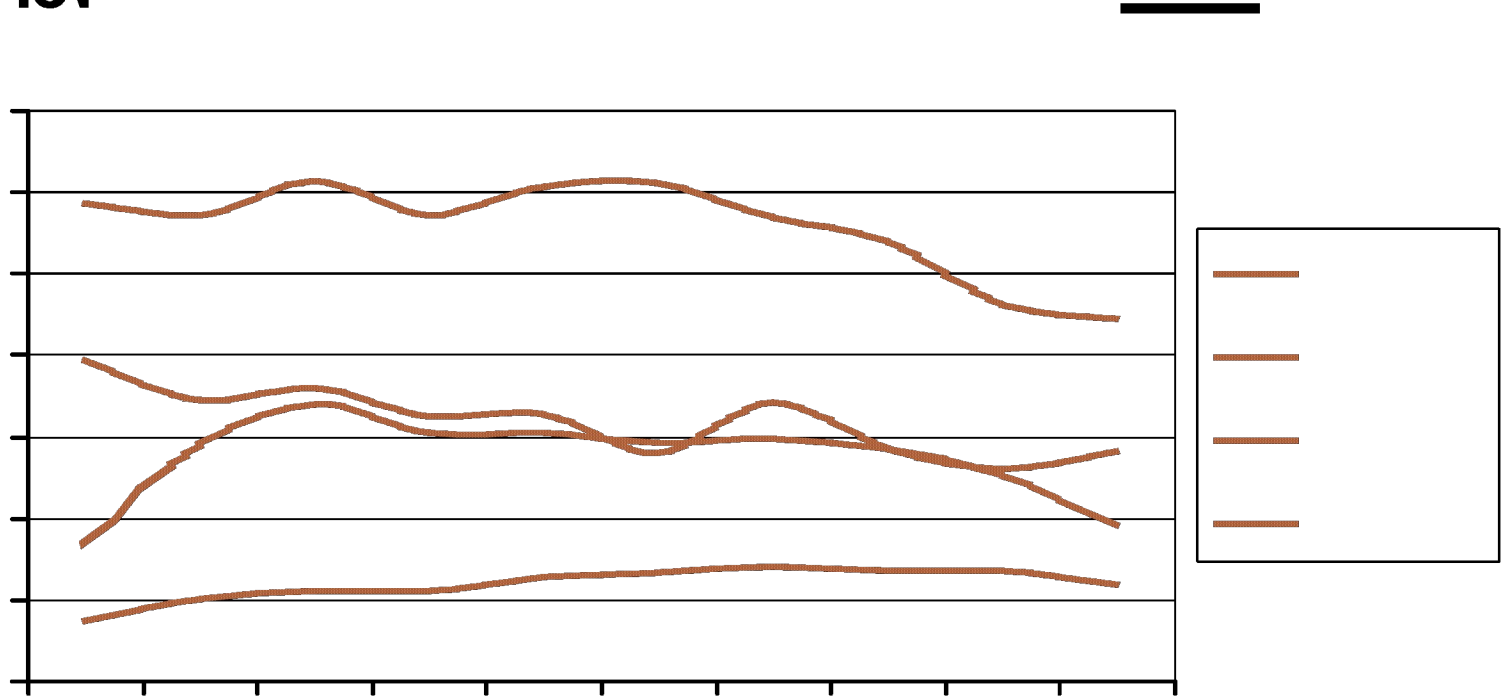

(successful business actions per minute, in average)

# WORKLOAD & RECORD VERSIONS, FW = ON (1/2)

Attaches: 100. Warm-up: 10 min. Measure: 180 min.

Table: **producer** of quantity for FIFO distribution

**Total Versions / Total Records, %:**

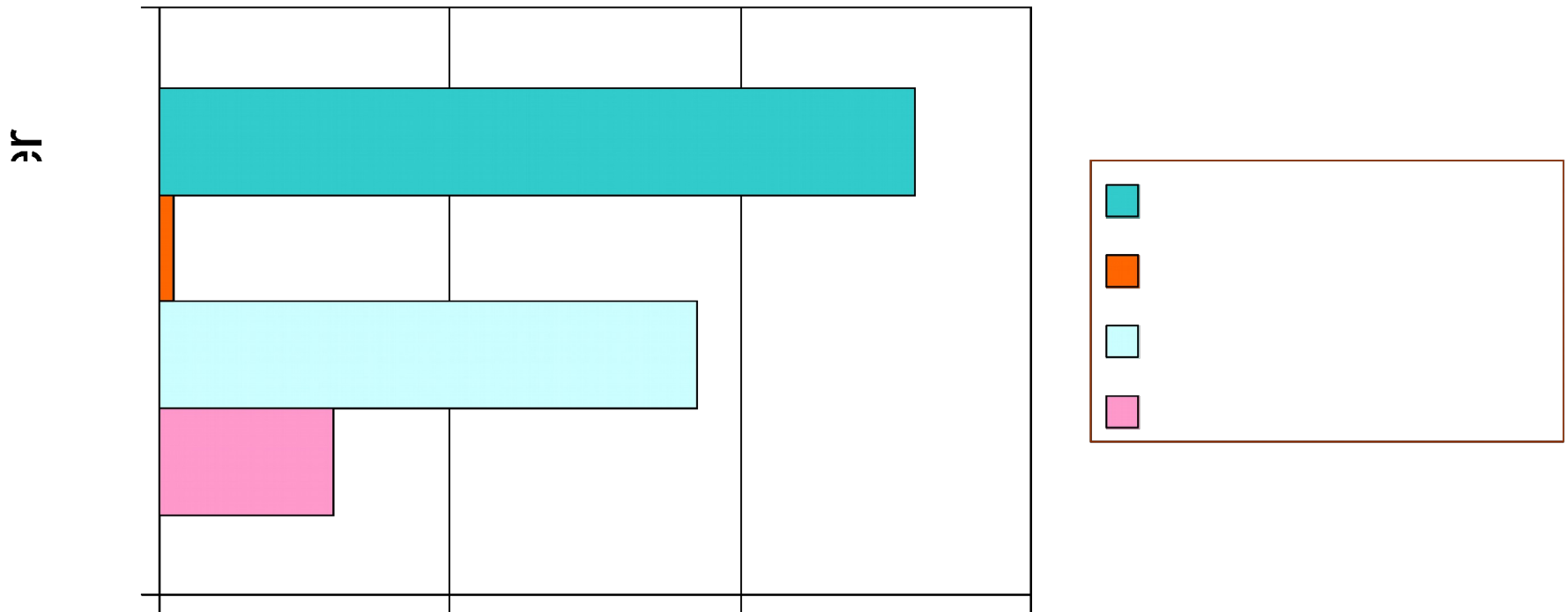

# WORKLOAD & RECORD VERSIONS, FW = ON (2/2)

Attaches: 100. Warm-up: 10 min. Measure: 180 min.

Table: **consumer** of quantity after FIFO handling

**Total Versions / Total Records, %:**

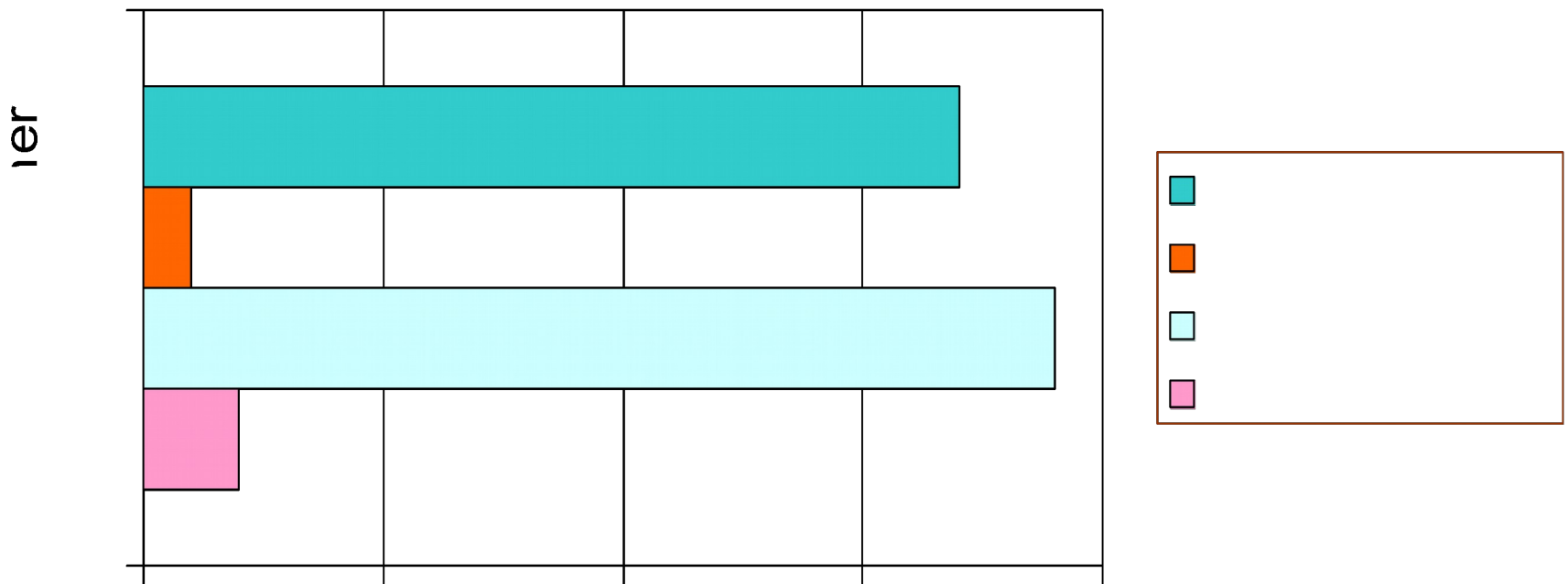



# WORKLOAD & RECORD VERSIONS, FW = OFF (1/2)

Attaches: 100. Warm-up: 10 min. Measure: 180 min.

Table: **producer** of quantity for FIFO distribution

**Total Versions / Total Records, %:**

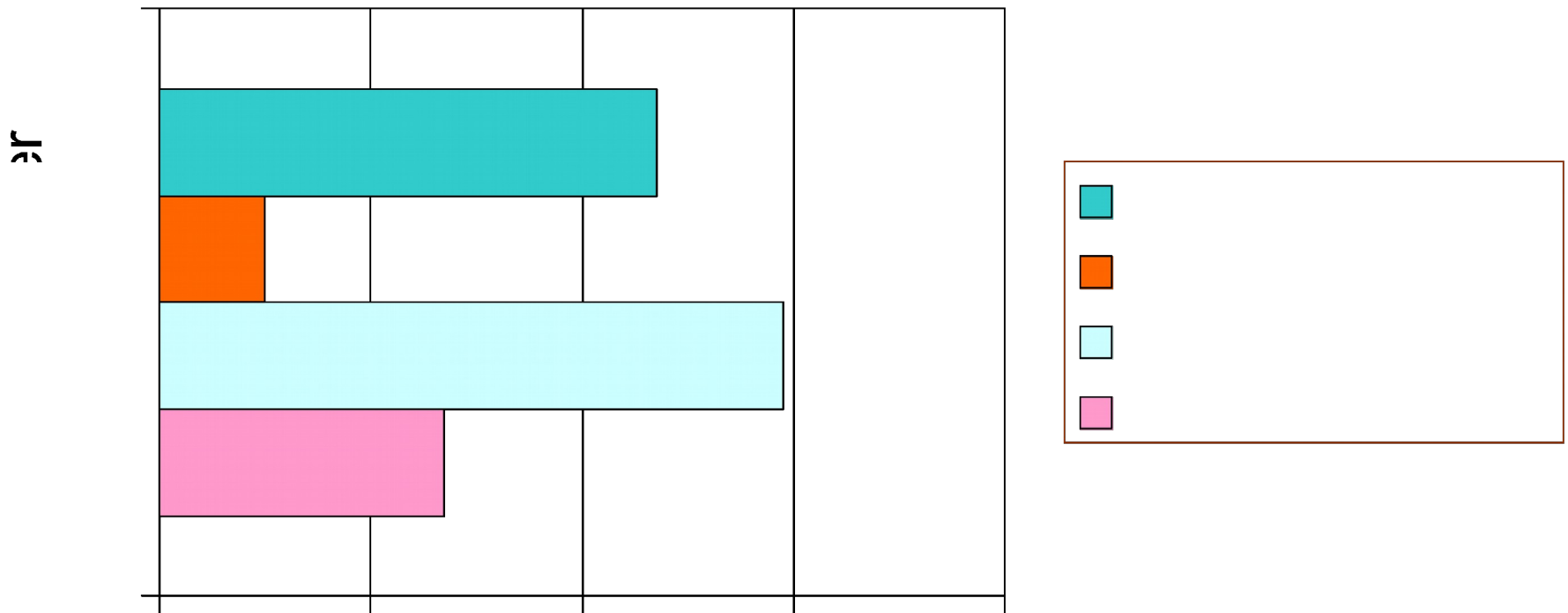

# WORKLOAD & RECORD VERSIONS, FW = OFF (2/2)

Attaches: 100. Warm-up: 10 min. Measure: 180 min.

Table: **consumer** of quantity after FIFO handling

**Total Versions / Total Records, %:**

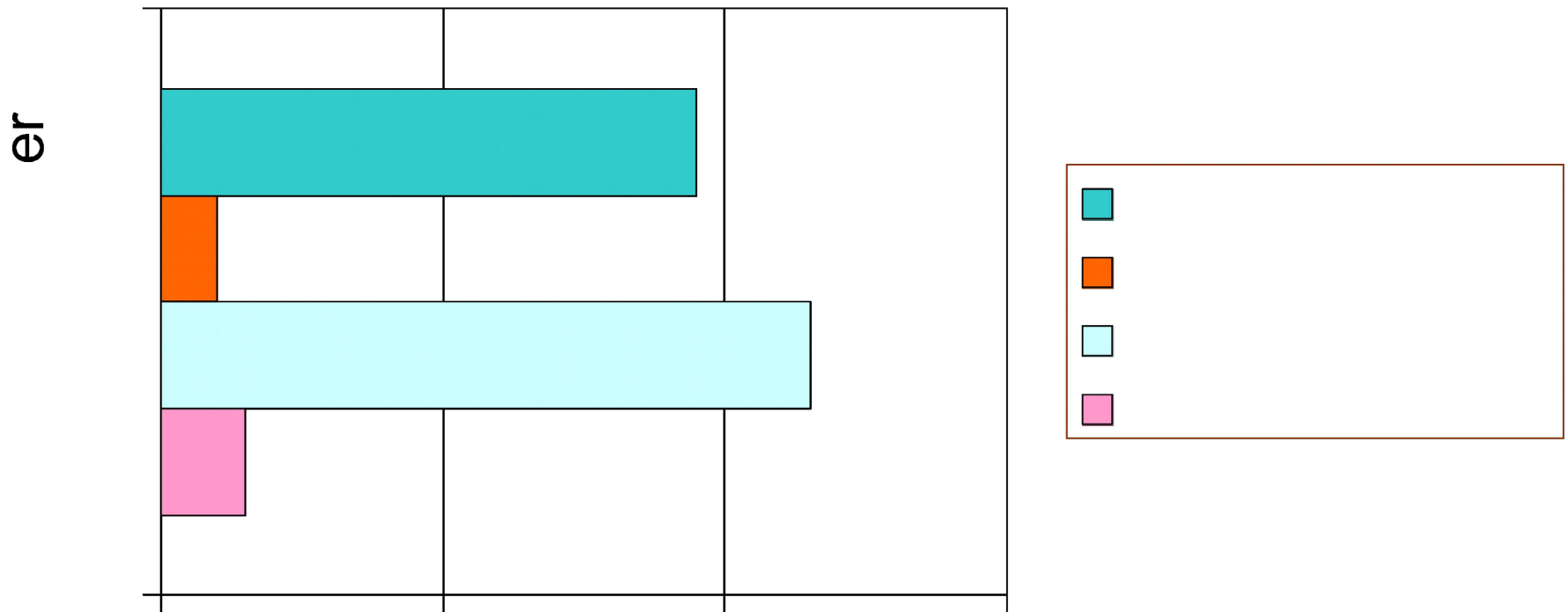

# BUGS & ODDITIES

Total detected bugs: more than 30 (see doc & tracker).

## **Not fixed yet:**

Spontaneous crashes, 3.0 SC, without adding any message in firebird.log. Database appears broken after this. No bugchecks.

Bugchecks with text about 'wrong record length', in 3.0 only

"Page type 4 (or 5) lock denied" in firebird.log, in 3.0 only

"I/O error during read file "fb\_table\_\*\*\*", file exists", in 3.0 only

Standard error messages that should be shipped to client occurs in firebird.log

Attempts of PK violations where bulk of undo occurs (when one of testing machines hangs etc). Firebird 3.0 crashes when workload more than 200 attaches.

# GOOD NEWS

- Monitoring was greatly improved in 3.0;
- New monitoring counters and especially table `mon$table_stats` - the “golden key” in search of performance bottleneck;
- Overall impression about current 3.0: much stable than it was in aug. 2013
- Sounds like paradox but: currently 3.0 SuperServer is more stable than all others (2.5 and 3.0 SuperClassic!)

**QUESTIONS?**